

Zoom Lens

This zoom lens is designed for use with Panasonic's applicable projectors. The lens makes it possible to vary the projection distance by changing the focal distance.

NOTE: Please use the lens only on the specified Panasonic projector.

Specifications

F value:	2.5
Focal distance (f):	35.0– 50.9 mm
Throw ratio:	1.7–2.4:1 for PT-DZ21K/DZ8700/DZ110X (16:10 aspect ratio), 1.8–2.6:1 for PT-DS20K/DS8500/DS100X (4:3 aspect ratio), 1.8–2.7:1 for PT-DW17K/DW8300/DW90X (16:9 aspect ratio)
Dimensions (W × H × D):	134 × 134 × 265 mm (5-9/32 × 5-9/32 × 10-7/16 inches)
Weight:	Approximately 5.2 kg* (11.5 lbs*)
Applicable projector	[Group A] PT-DZ21K/DZ21K2/DS20K/DS20K2/DW17K/DW17K2/DZ16K/DZ16K2 [Group B] PT-DZ13K/DS12K/DW11K/DZ10K/DZ8700/DZ110K/DS8500/DS1100K/DW8300/DW90K [Group C] PT-RZ12K/RS11K PT-RQ13K

*Average value. May differ depending on the actual unit.
The throw ratio is an approximate value calculated by dividing the screen width by the projection distance.

Dimensions

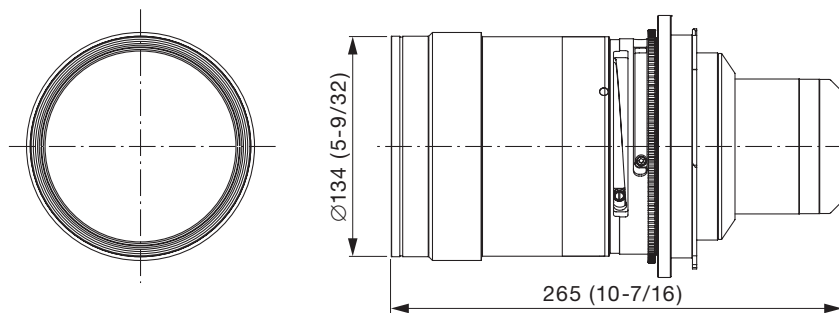

unit : mm (inch)

NOTE: This illustration is not drawn to scale.

NOTE: Please read the projector's instruction manual for throw distances.
Weights and dimensions shown are approximate. Specifications subject to change without notice.

[Group A]

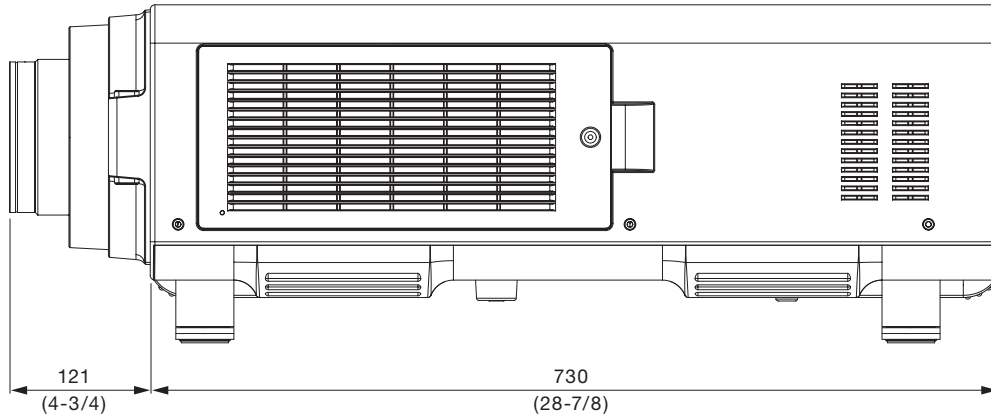

[Group B]

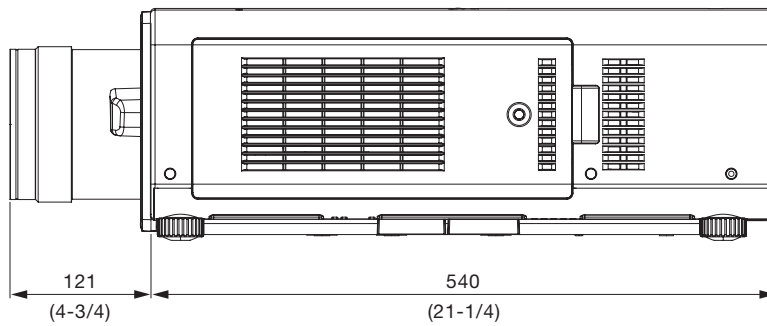

[Group C]

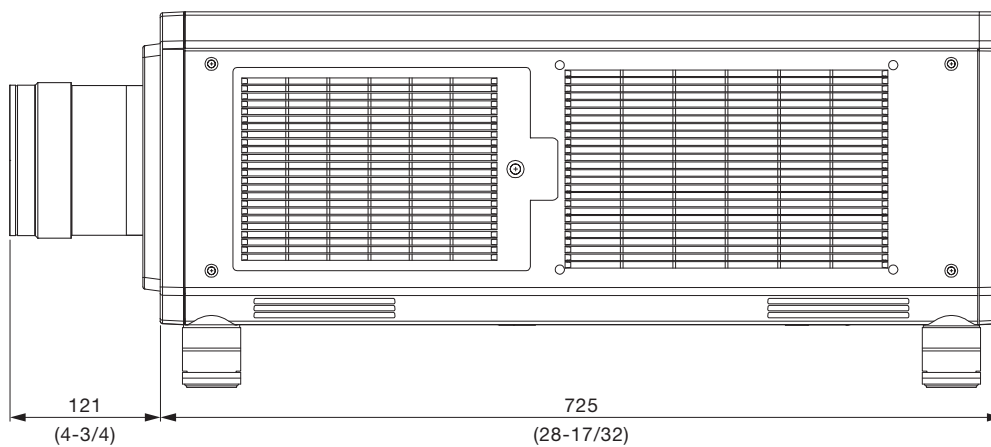

unit : mm (inch)
NOTE: This illustration is not drawn to scale.

NOTE: Please read the projector's instruction manual for throw distances.
Weights and dimensions shown are approximate. Specifications subject to change without notice.